

Micron MR001c Quick Start Guide

This guide is designed to get you started with MR001c as quickly as possible. More information can be found in the user manual - <http://micronrc.uk/mr001c-info>.

MR001c is a 2.4GHz DSM2/DSMX 10 output receiver designed for model railway use. It is suitable for live steam and large battery electric locos. It can be used to drive servos, speed controllers and LEDs.

If purchased with a transmitter, MR001c will be bound to the transmitter and is ready for use; otherwise, it requires binding to your transmitter. Once bound, the transmitter should be switched on before the MR001c. If the transmitter is not switched on, MR001c will automatically enter bind mode 5 seconds after switch on; it also be manually bound using a jumper plug on the P5/P7 signal pins.

Usage

- Do not bend the receiver circuit board or use with the protective sleeve removed.
- Ensure unused pins of P1..P7 cannot contact any metal.
- Connect to a battery or ESC output that can provide 3.5V to 8.5V under load. Some servos can draw a heavy current when starting to move and the voltage of a 'tired' 4 cell NiMH battery may dip below 3.5V causing MR001c to reset. If this happens, a 5 cell NiMH battery will give better results. A resettable fuse in the battery positive lead is recommended to protect the battery in the event of a wiring or component fault. If you need to power from a single LiPo cell (e.g. because of space reasons), a 5V or 6V booster should be used.
- If MR001c has not been supplied configured for your use, set the [throttle mode](#), Selecta and Cruise control features as required (see '[Power-On-Changes](#)').
- If required, bind to your transmitter (see '[Binding](#)').
- Connect your servo(s) or speed controller to the appropriate pins (see '[Connection Diagrams](#)') and adjust the servo direction and/or travel as required (see '[Servo Adjustment](#)').
- Fix MR001c in place and route the aerial(s) to that the last 30mm can 'see' the transmitter for best range - e.g. by routing through a hole in the vehicle body. The aerial should not be cut short or made longer as this will affect operation. It is important to perform a range check after installation to ensure you have full control of your loco at all positions around the layout. Double sided foam-cored sticky tape is ideal for mounting the receiver.

Binding

To bind:

1. with transmitter off, switch MR001c on
2. wait for the RF LED to flash fast
3. switch your transmitter on in bind mode
4. the RF LED will stop the rapid flash, flash a couple of times randomly and then light continuously
5. MR001c is now bound to your transmitter

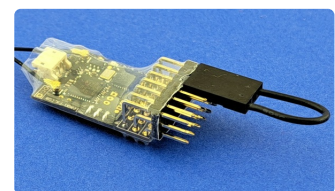

Manual Bind

If the receiver RF and CPU LEDs do not come on solid (no flash) within 10-15 seconds, the bind process has failed. This can happen for several reasons and does not normally indicate a fault. If you get a bind fail, try again after moving the Tx and Rx slightly further apart or changing the relative orientation of the aerials. Binding is most reliable when no other 2.4GHz transmitters are turned on.

Connections

MR001c has 7 sets of output pins which can be used for servos, speed controllers or LEDs for lighting. The pin sets, numbered from the top of the diagram below, are 0.1" pitch to take standard R/C plugs.

An additional 8th output for LED or sound card trigger is available via a JST-ZH socket and a 9th and 10th output are on an optional Molex Picobade socket. These connectors are at the rear of the receiver and, although P8 has 3.3V and 0V pins, it cannot be used for powering a servo as the 3.3V pin is

supplied from the on-board regulator which has insufficient current capacity for a servo.

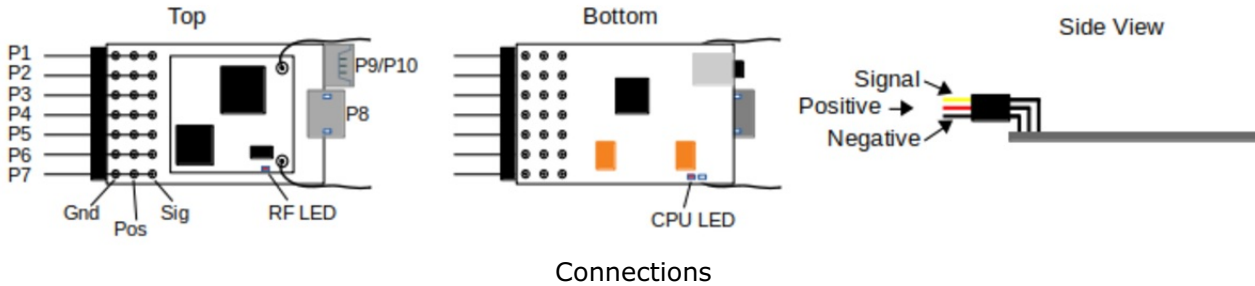

Connectors with leads are optionally available for P8 and P9/P10.

Throttle Modes

The transmitter's throttle control is output on P1 to drive a regulator servo or an external speed controller. The throttle mode is used mainly to control how the directional lights operate and to close the throttle if the emergency stop feature is enabled or cruise control is disabled. Also, there will be no output from P1 until MR001c has received a valid stop throttle signal.

The 3 throttle modes are:
centre-off

Forward and reverse on one transmitter control with stop in the centre. Best used with an external forward/reverse speed controller connected to P1 as shown in the 'ESC Connection' diagram. MR001c is powered from the speed controller's 5V output. This is the default mode and MR001c will be supplied centre-off unless otherwise requested.

low-off

Separate transmitter controls for speed and direction which are output on P1 and P3 (R/C channels 1 and 3). This mode is suitable for most live steam locos.

low-to-centre

Separate speed and direction transmitter controls are combined into one forward/reverse output on P1. This mode is intended for battery electric locos where the user prefers separate controls or who wants to use a transmitter for both live steam and battery locos.

The throttle control min and max positions will require calibration the first time MR001c is switched on in this mode. After initialisation, the CPU LED will display a repeated pattern of 1 long flash followed by 1 short flash. Move the transmitter throttle control to its minimum CCW position (stop) then move it to the maximum CW position (full speed) and finally back to stop. The CPU LED will then light continuously.

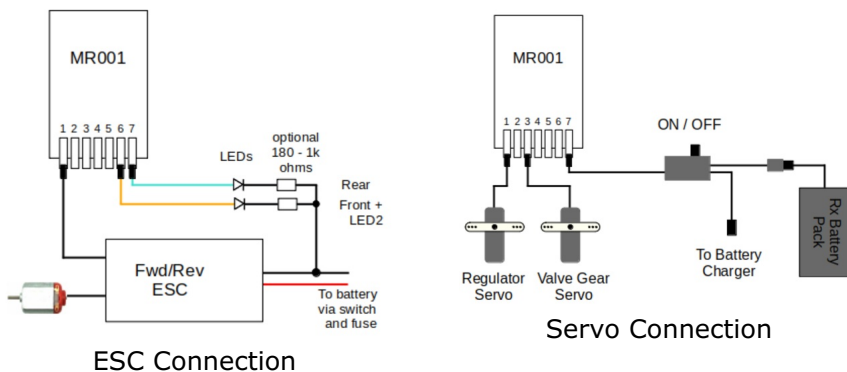

Power-on-Changes

Some MR001c configuration changes may be done using one or more jumpers placed on the P1..P7 signal pins before the receiver is switched on. The CPU LED will display a flash pattern corresponding to the selected change. The table below summarises the available changes and the associated flash patterns.

The changes all cycle though the flash counts while the jumper is installed. Each flash count is repeated once (i.e. shown twice) and then increments to the next, cycling back to 1 when the maximum is reached. When the desired flash count has been shown, removing the large jumper acknowledges the selection by showing a rapid flash. There will be a short delay between removing the jumper and the rapid flash due to the time taken to write the changes to permanent memory. The receiver should be powered off when the rapid flash starts. If you switch off before removing the

jumper connection, the configuration is not changed. If you switch off after removing the jumper and before the rapid LED flash, the receiver data is likely to be corrupted and you should perform a reset.

It is recommended to do a backup after making any other changes (including any programming via a transmitter - see <http://micronrc.co.uk/mr001c-progtable>).

Change	Large Jumper	Small Jumper	LED indication
Reset & Backup	P1/P3	-	n-flash where 'n' is: 1: do nothing 2: reset 3: backup 4: disable/enable ch2/ch4 programming
Configuration Select	P1/P3	P4/P5	n-flash where 'n' is the configuration number
Throttle Arm Mode	P1/P3	P5/P6	This controls the way that the throttle output (normally P1) behaves after switch on: 1-flash = disabled (output follows Tx throttle immediately) 2-flash = enabled (output disabled until Tx throttle at stop)
LED2	P2/P4	-	1-flash - disabled 2-flash = normal, not Select and not Cruise 3-flash = Selecta & Cruise 4-flash = always
Throttle Mode	P3/P5	-	1-flash = centre-off (thr=ch1) 2-flash = low-off (thr=ch1, dir=ch3) 3-flash = low-to-centre (thr=ch1, dir=ch3)
Selecta	P4/P6	-	1-flash = disabled 2-flash = enabled
Cruise Control	P4/P6	P1/P2	1-flash = disabled, stop in 4s after signal loss 2-flash = enabled, continue running while no signal
Bind	P5/P7	-	rapid flash indicates bind mode

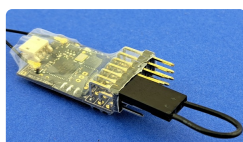

P1/P3 - Reset & Backup



P1/P3, P4/P5 - Config Select

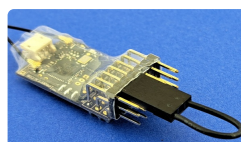

P2/P4 - LED2

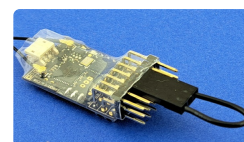

P3/P5 - Throttle Mode

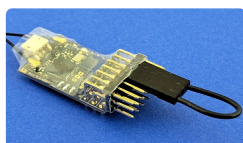

P4/P6 - Selecta

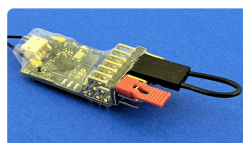

P4/P6, P1/P2 - Cruise

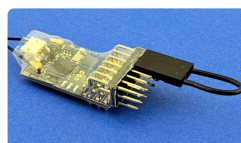

P5/P7 - Bind

See the [user manual](#) for more details.

Servo Adjustment using Jumper Plugs

Servo throws (low and high end points) and reversing can be configured in 2 ways:

- using the small and large jumpers for adjusting P1..P7
- by using a transmitter for adjusting P1..P10

Use of jumper plugs will be described here, see <http://micronrc.co.uk/mr001c-info> for details on how to use a transmitter to adjust servo throws.

WARNING: never place the small jumper across the positive (middle row) and negative (bottom row) pins. This will short the battery.

Step 1 - select a servo output to adjust

Use the small jumper plug to select a servo output to adjust. It is placed across the signal pin (top row) to be

adjusted and the adjacent signal pin. For example, to select P1 (throttle), place the small jumper plug across signal pins 1 and 2 as shown in the image (the black connector in the image is the battery plugged into P4). The standard MR001c setup has servo outputs on P1..P5. If your receiver has servo outputs on P6 and/or P7, these may also be adjusted - P7 requires use of both small and large jumper plugs.

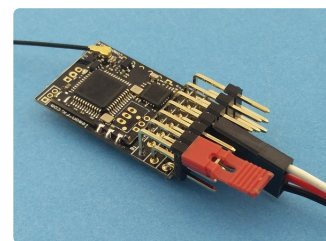

Select P1 to adjust

Steps:

1. MR001c must already be bound to your transmitter
2. receiver off and transmitter on
3. place the small jumper and then connect the battery:
 - o P1: small on P1/P2, battery on P4
 - o P2: small on P2/P3, battery on P4
 - o P3: small on P3/P4, battery on P1
 - o P4: small on P4/P5, battery on P1
 - o P5: small on P5/P6, battery on P4
 - o P6: small on P6/P7, battery on P4
 - o P7: small on P1/P2 and large on P5/P7, battery on P4
4. the CPU LED will flash a sequence twice to indicate the selected pin set and then flash rapidly - e.g. flash pause flash pause rapid for P1, flash flash pause flash flash pause rapid for P2, and so on
Note: if the selected pin is not currently configured as a servo the CPU LED will not flash the pin number sequence and go immediately to rapid flashing; the receiver will not respond until it is switched off and back on again
5. remove the small jumper plug when the CPU LED is flashing rapidly, **do not remove the battery**
6. connect a servo, this will respond to the transmitter control
 - o no other output pin is active

The servo output is now selected. Jumper plugs are used on P6 and P7 (or P1 and P2 for adjusting P6 or P7) to reverse the servo or adjust the travel end points. Reversing or end point adjustment can be repeated as often as desired while the servo is selected. To stop the process, remove power from the receiver.

Reverse servo direction

The small jumper plug is placed across signal pins P6 and P7 (or P1 and P2 if adjusting a servo on P6 or P7).

Steps:

1. select servo output to adjust and plug servo in
2. place the small jumper across signal pins P6 and P7 (or P1 and P2 for a servo on P6 or P7)
3. the CPU LED will flash rapidly
4. remove the jumper and the CPU LED will stop flashing
5. the servo will respond to transmitter controls in the opposite direction to previous

The servo direction will reverse each time the procedure is executed.

Adjust servo travel

Servo travel end points can be increased or decreased using the large jumper plug on P6 (decrease) or P7 (increase) - P1 and P2 for servos on P6 or P7. The adjustment is done in small steps every 1/2 second and the CPU LED flashes for each step.

To make an adjustment:

1. move the servo to the low or high end using the transmitter control
2. use the large jumper to make changes:
 - o on P6 to decrease the throw (P1 for servo on P6/P7)
 - o on P7 to increase the throw (P2 for servo on P6/P7)
3. either remove the jumper or move the servo away from the end to stop the adjustment

The CPU LED will stop flashing and the servo will stop moving when the adjustment limit is reached.

- The limit for decrement is the mid point of travel so, if an end point is decreased to the maximum amount, there will be no servo travel in that direction when the transmitter control is moved.
- The limit for increment is the maximum signal value. **Take care:** not all servos will respond to the maximum range of servo signal values; stop decrementing when the servo stops moving even though the CPU LED is still flashing.